

# OWNER'S & INSTALLATION MANUAL

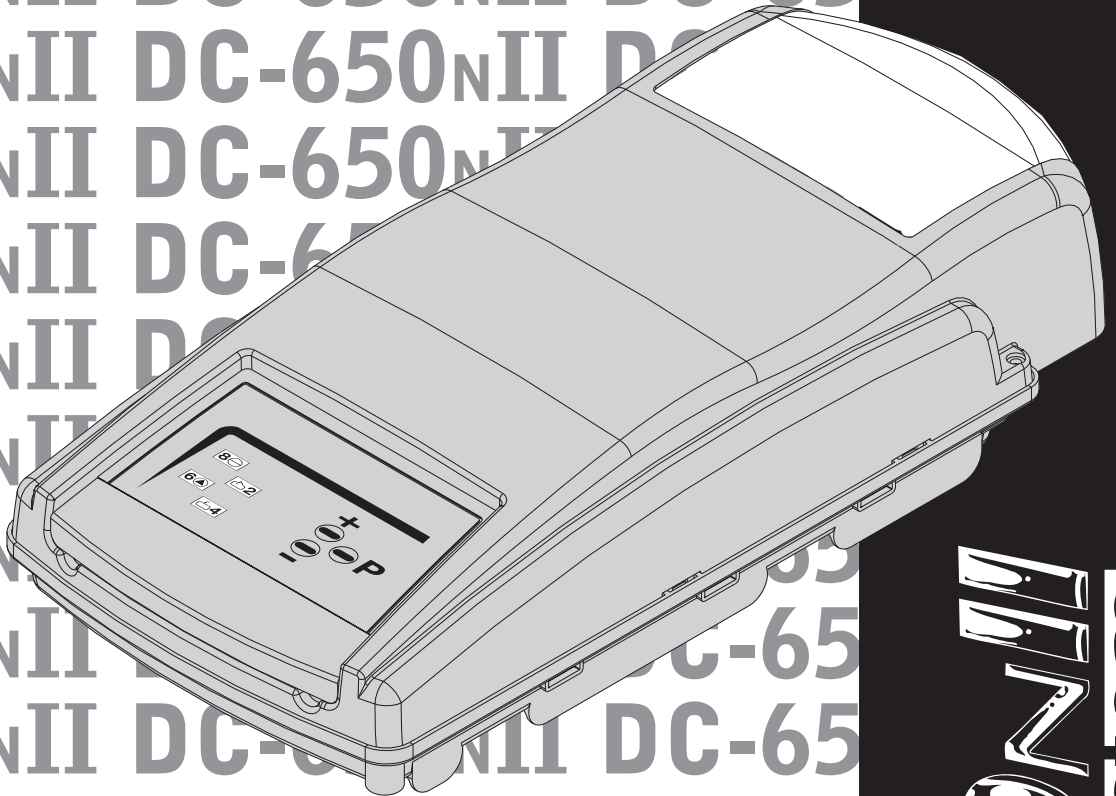

CARDALE  
GARAGE DOORS



**DC650NII**  
smart entry system

## **⚠ IMPORTANT SAFETY INSTRUCTIONS FOR INSTALLATION**

### **WARNING – INCORRECT INSTALLATION CAN LEAD TO SEVERE INJURY FOLLOW ALL INSTALLATION INSTRUCTIONS CAREFULLY**

Before installing the operator check that the door is in good mechanical condition, and correctly balanced, and that it opens and closes properly.

- Do not use the force adjustments to compensate for a binding or sticking garage door. Excessive force will interfere with the proper operation of the Safety Reverse System or damage the garage door.
- Do not wear rings, watches or loose clothing while installing or servicing a garage door operator.
- To avoid serious personal injury from entanglement, **remove any ropes** connected to the garage door before installing the door operator.
- Install the remote mounted bell push button within sight of the door but away from any moving parts and at a height of at least 1.5 metres.
- **The safety reverse system test is very important.** The garage door must reverse when obstructed on closing. **Failure to properly adjust the operator may result in serious personal injury from a closing garage door.** Repeat the test once a month and make any needed adjustments (see Advanced Settings **Level 2**, Menu **2** and Menu **3** on page 20 of this manual).

Installation and wiring must be in compliance with your local building and electrical codes.

- If the garage has no service entrance door then an exterior release kit **MUST** be fitted. This accessory allows manual operation of the garage door from outside in case of power failure.
- Disconnect electric power to the garage door operator before making repairs or removing covers.
- Use the manual release lever to disengage the motor drive **ONLY** when the drive is switched OFF and, if possible, when the door is fully closed.
- Examine the installation, in particular the cables, spring and mountings, for signs of wear, damage or imbalance. Do not use if repair or adjustment is needed since a fault in the installation or an incorrectly balanced door may cause injury.

### **IMPORTANT SAFETY NOTE**

Only operate the door when the door is in full view, free of obstacles with no persons (particularly children) near the door. Nobody should be allowed to enter or leave the garage whilst the door is in motion.

#### **Copyright:**

No part of this manual may be reproduced without prior approval.  
Subject to alterations in the interests of technical progress.

Please keep this manual for future reference, repair and maintenance.

**INTRODUCTION**

Congratulations on the purchase of your new automatic garage door operator. It is designed to offer you convenience, durability and quality. This operator has been factory tested to ensure maximum quality and safety.

In order to prevent damage to the garage door or garage door operator and to comply with the Machinery Directive it is important that this operator is fitted in accordance with these instructions.

**CONTENTS**

Drive rail supplied in separate carton.

<p>Pack art. nr. 48170</p> <p>Fix draw bar</p>	<p>Pack art. nr. 8055306</p> <p>Bracket to door (only Cardale)</p> <p>Track to header</p>
<p>Pack art. nr. 48116</p> <p>Draw bar to door</p>	<p>Track to power head</p> <p>Bracket to door (non-Cardale)</p> <p>Track mounting</p>

## SAFETY FEATURES

- **Automatic Door Reverse**  
An unmodified closing door will automatically reverse within 2 seconds if door is obstructed by person or object.
- **Automatic Time Reverse**  
Closing door will automatically reverse if the door is not fully closed within 88 seconds.
- **Safety Stop**  
Opening door will immediately stop when obstructed by person or object.
- **Beam Break**  
For additional safety we recommend a Beam Break is installed. If the INFRARED BEAM is broken by a person or object whilst the door is closing, it will automatically reverse to the fully open position without actually having touched the closing door itself.

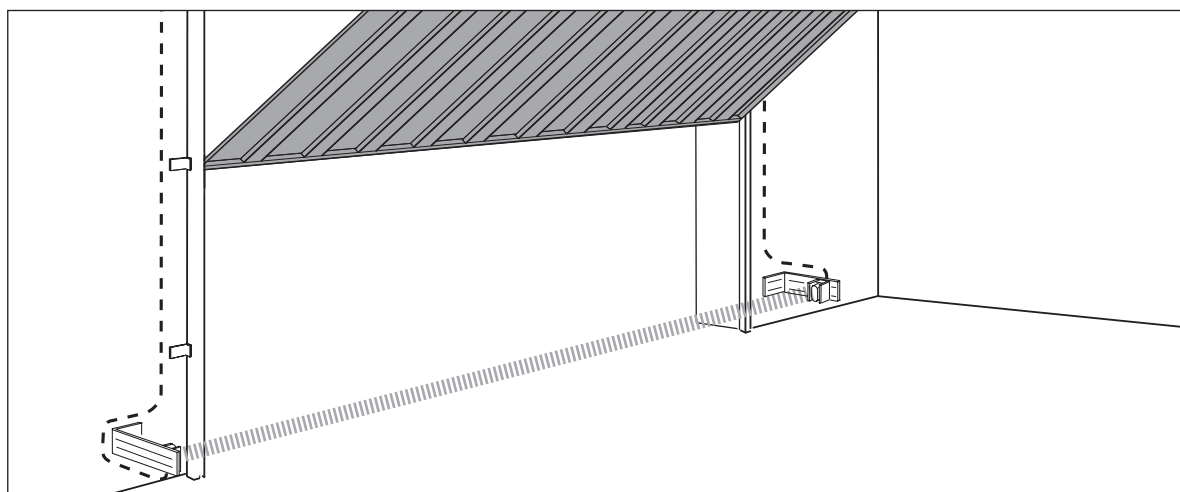

## OPERATOR ASSEMBLY

**Note:** Where the operator has been specified with a 2-piece boom, please refer to the assembly instructions for this item supplied with the boom.

### 1 Install grey motorshaft adapter onto motorshaft (if not already fitted).

Bolt rail with brackets and screws to motorhousing. Make sure the screws are tightly fastened. N.B. Use 4 large Phillips HD selftap screws provided

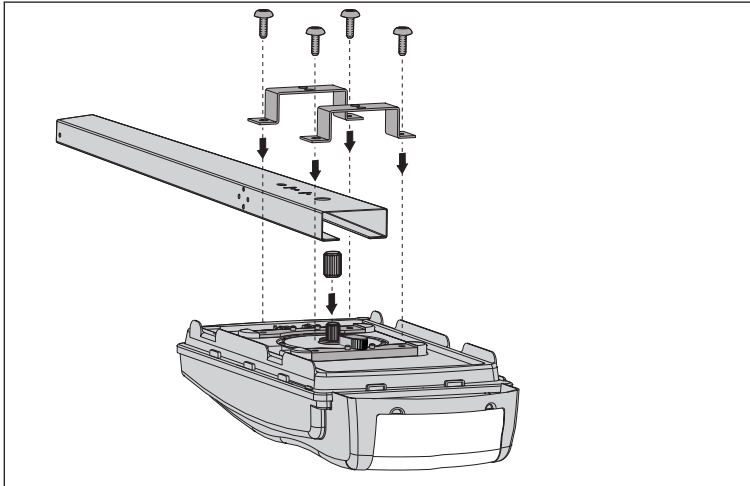

Lens cover should face rear of garage.

### 2 Fit the red slider that re-engages the emergency release and operator pull bar onto carriage.

- Refer to fig.1 to fit the red slider that re-engages the emergency release knob onto carriage.
- Refer to fig.2 to fit pull bar onto carriage. Note position of emergency release cord to ensure correct cord position after installation.

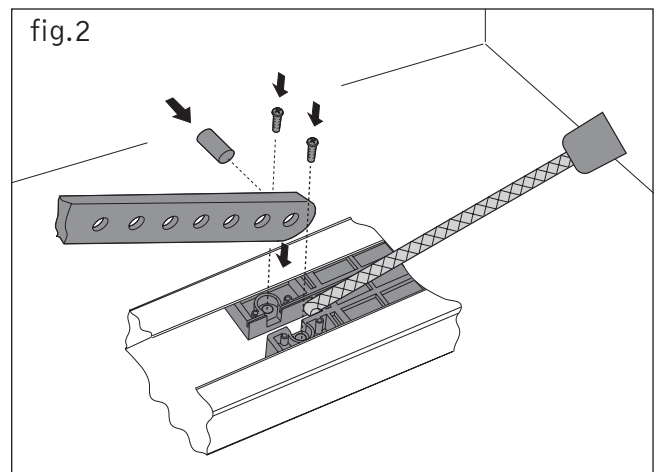
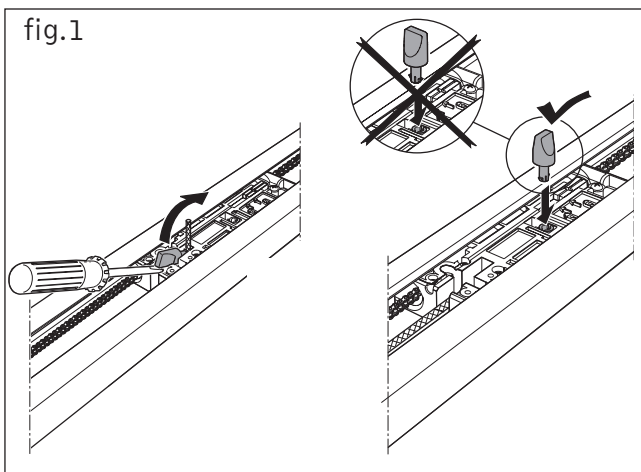

### 3 Carriage quick release.

- a. Pull cord "a" to disengage. Carriage re-engage remain disengaged. See fig. 3
- b. Move red slider "b" in direction of arrow to re-engage carriage at next movement. Start operator. See fig. 4.

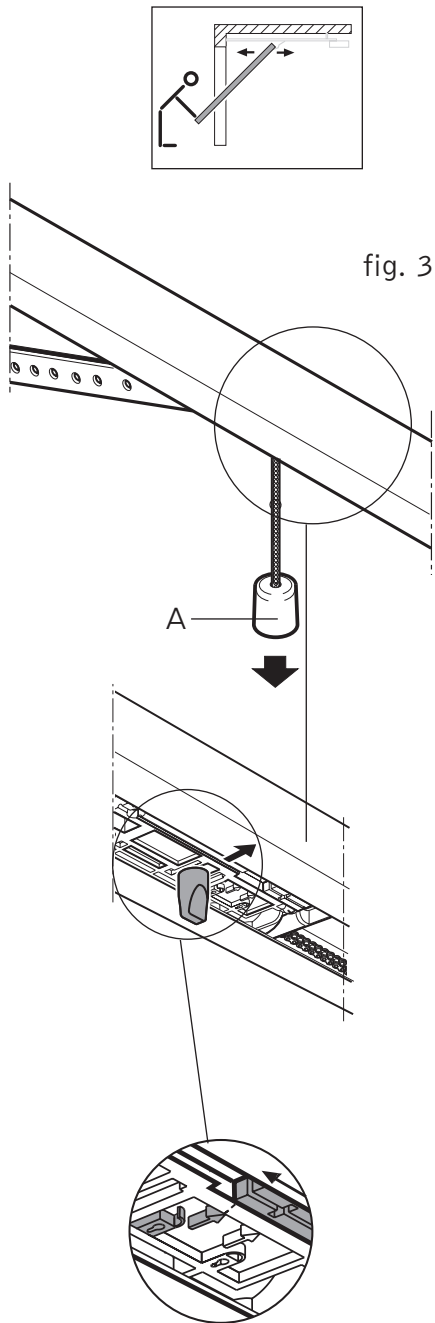

fig. 3

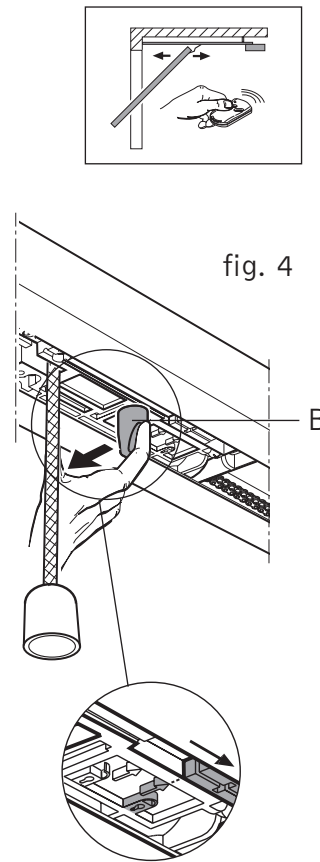

fig. 4

## OPERATOR INSTALLATION

### DETERMINE GARAGE DOOR TYPE

Determine your garage door type as indicated in Step **4A** or **4B**.

Follow the individual instructions required for your specific garage door type.

If your garage door type is not included, please contact your distributor.

Special accessories or operator modifications may be required.

#### **4A** 1-Piece up-and-over doors

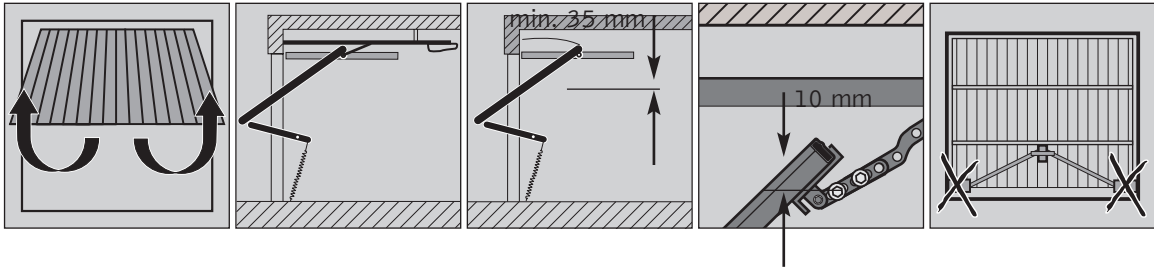

Install door bracket at centre position of door and rail bracket on centre position above door. Make sure there is at least 10 mm clearance between highest travel point of door and rail.

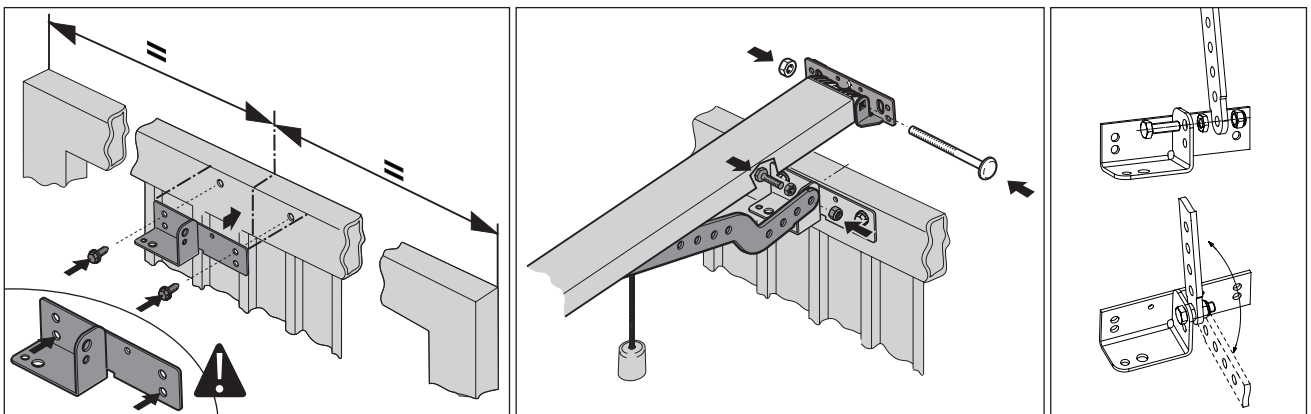

**!** For doors fitted with 3 point latching: Before fitting the door bracket to the door, the top latch assembly must be removed. For GRP doors only –also remove the retaining screws alongside the door bracket fixing holes. When fitting the door bracket, use the lower holes for GRP doors only and the upper holes for all other doors.

- Level and mount operator.

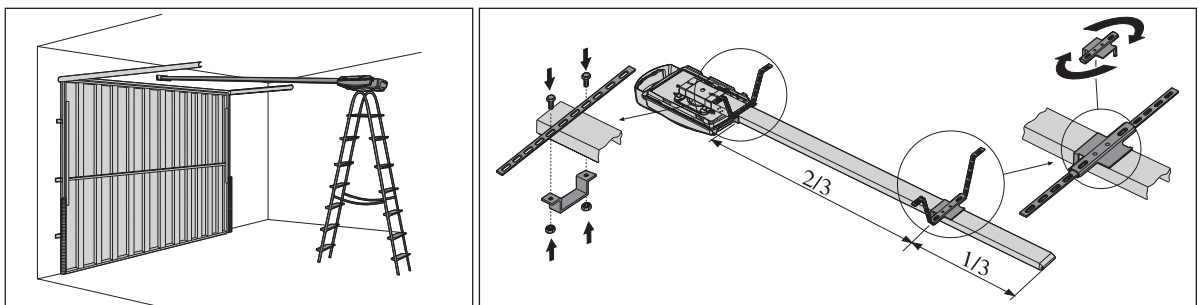

- Disengage carriage from chain or belt! Door may only be moved with moderate speed.
  - Connect operator pull bar to door bracket.
- Note: Remove or disengage all door latches and disable the door lock prior to installation!**

4B

Sectional doors

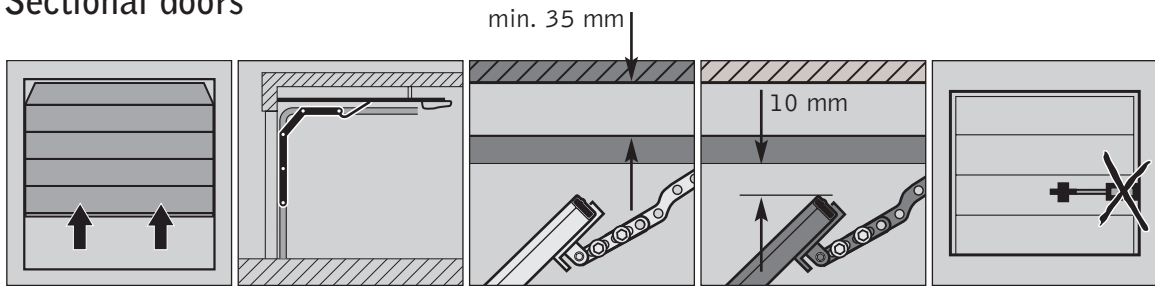



**ATTENTION**

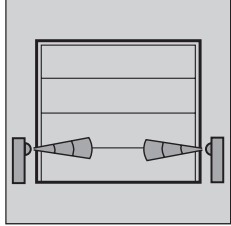

A beam break is strongly recommended for use with sectional doors (available separately).

- Fix adjustable door fitting bracket to top section at the centre of the door.

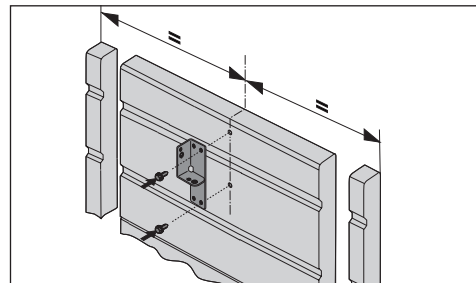

- Install rail bracket on centre position above door. Make sure there is at least 10mm clearance between highest travel point of door and rail.

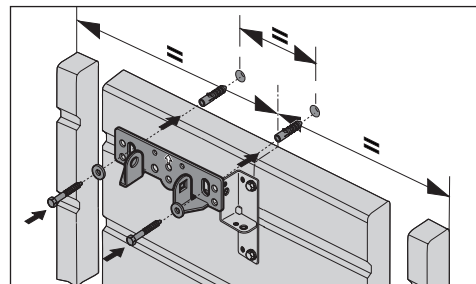

- Level and mount operator.

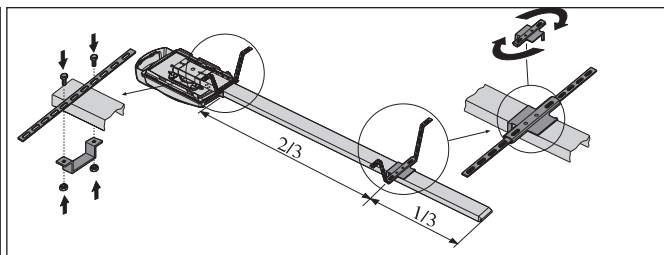
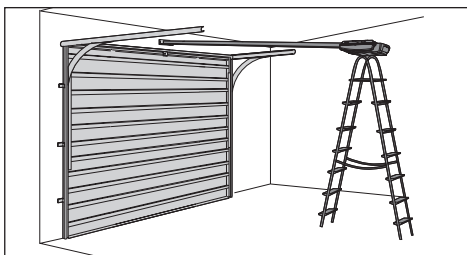

- Disengage carriage from chain or belt.

Door may only be moved with moderate speed.

- Connect operator pull bar to door bracket.

**Note:**  
Remove or disable all door locks before installation!

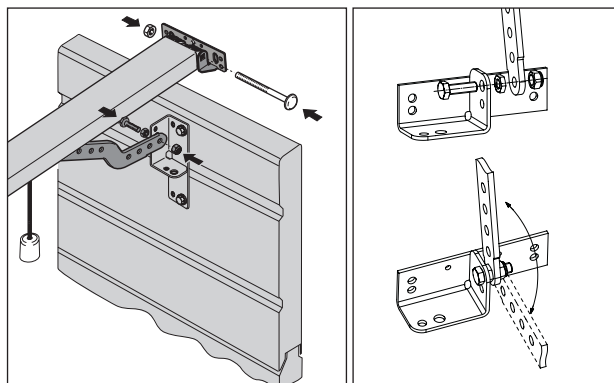



FOR ALL OTHER DOOR TYPES PLEASE CONTACT YOUR DISTRIBUTOR!

**5** Make sure motorhousing and rail are mounted correctly and secured.  
Strengthen where needed.





**6** Install light bulb.  
Type E14, max. 40 Watt.

**!** Attention: before you start Operator programming please make sure your carriage is engaged to chain or belt and door arm is attached to door.



## OPERATOR CONTROL PANEL INDICATIONS

Your automatic door operator is provided with an easy to read LED display panel with 4 light icons and three program buttons.





### Light icons

-  1 door fully open
-  2 door fully closed
-  3 operator impulse (slow flash when on vacation lock)
-  4 power on (230V)

### Adjustment buttons

-  Program button "decrease" and CLOSE test button
-  Program button "increase" and OPEN test button
-  Programming button

### LEGEND

LED off i.e.   
LED illuminated i.e.   
LED blinking i.e.   
LED rapid blinking i.e. 

Button pressed  or  or 

Default setting:

i.e.



## PREPARATION FOR PROGRAMMING

- The operator has to be mounted ready for operation
- The door is not yet closed completely
- If there is a beam break (photocell), it should be connected!



### Advice:

If the photocell is correctly mounted and aligned, the function 'photocell' is recognized automatically during programming!

- If applicable, before programming the operator, stick battery into your hand transmitter(s).
- When the door operator is turned on (plug in power cord) it runs a self-test; all 4 LEDs will glow and operator 230V light will illuminate for approximately 2 seconds. When the light is off and LED is illuminated the operator is in normal operating mode.

### ADJUSTMENT BUTTONS:

All settings and adjustments can be made with the three adjustment buttons.

Use and to change settings of chosen program menu  
 to store menu setting and go to next menu.



### Advice:

The programming is cancelled if none of the three buttons (, , ) is actuated during a time period of more than 120 sec.

All functions saved before with button remain unchanged.

When programming is cancelled, LED is flashing.

After shortly pressing button the error message 1 is displayed.



### Attention:

The operator has **two** programming levels.

For normal operation of the operator you only program the end positions and the remote control in the Basic settings.

**Changes in the extended programming level may only be carried out by specialists.**



### Advice:

To determine the error number add the figures of the irregularly flashing LED's. See as well 'error messages'.

In case of a malfunction the control light MALFUNCTION is flashing.

- Shortly press button .  
-> The current error number is displayed by irregularly flashing LED's (e.g. error and ).

**Advice:**



The end positions can only be programmed if there is a valid reference point.  
For this travel the door electrically once to open or close position.

**Display of the reference point**

The operator passes the reference point sensor:

- LED  shortly glows up.

**Advice:**

All menus can be reset by a RESET function to the original values set by factory.  
Reset is activated by pressing ,  and  together for more than 30 seconds.

## OPERATOR PROGRAMMING - BASIC SETTINGS

### MENU OVERVIEW:

- ① Set door OPEN position
- ② Set door CLOSED position
- ③ Program hand transmitter

### TO SET UP THE OPERATOR:

#### Menu ①

##### SET DOOR OPEN POSITION

1. Press **OP** for 2 seconds until LED  blinks and all others are illuminated.
2. To move the garage door to desired fully OPEN position press & hold the  until desired DOOR OPEN position is reached.  
For fine-tuning use the  (OPEN) and  (CLOSE) buttons.



#### Advice:





The reference point has to be passed 1x.

 will light up briefly when reference point has to be passed 1x.

3. Press **OP** to store and to go to Menu ②.

#### Menu ②

##### SET DOOR CLOSE POSITION

1. LED  blinks and all others are illuminated.
2. To move the garage door to desired fully CLOSED position press & hold the  until desired DOOR CLOSE position is reached.  
For fine-tuning use the  (CLOSE) and  (OPEN) buttons.



#### Advice:

The reference point has to be passed 1x.

 will light up briefly when reference point has to be passed 1x.

3. Once door position is correct press **OP** to store and go to Menu ③.

## Menu 3

### PROGRAM THE TRANSMITTER CODE

1. LED **3** blinks and all others are illuminated.
2. Press transmitter button until LED **3** blinks rapidly
3. Press **P** to store multi-bit transmitter code and to finish basic programming. LEDs will automatically turn off starting at LED **4** and ending at LED 2. The operator is now in operational (normal) mode **4**.

### **MAKING ADJUSTMENTS:**

To change the settings of an individual menu:

1. Press **P** for approximately 2 seconds until LED blinks
2. Repeatedly press **P** until desired indicator blinks.  
If an individual programming menu is skipped its settings remain unchanged.
3. Follow individual instructions for Program menu
4. Repeatedly press **P** to scroll through the menus. When you reach last menu by pressing **P** the LEDs will automatically turn off starting at LED **4** and ending at LED **1**.

## HOW TO PROGRAM AN ADDITIONAL TRANSMITTER



### Advice:

- Both sides of the plug connections can be used identically.
- For multi-channel hand transmitters this step has to be carried out separately for each button.



### Attention:

- An actuation of the hand transmitter may start the door movement!
- After the hand transmitter has been recoded, the garage door system to be actuated must also be reprogrammed to adopt the new coding, since the old coding has been irretrievably lost!

## Learning the coding

This function is meant to transmit the coding of an existing hand transmitter to an additional hand transmitter.

1

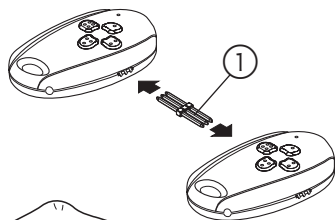

### Step 1

- Connect both hand transmitters by means of the enclosed coding plug ①.

2

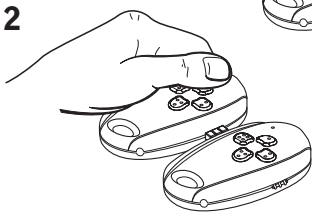

### Step 2

- Actuate the existing hand transmitter and hold the button.  
The LED on the transmitter is on.

3

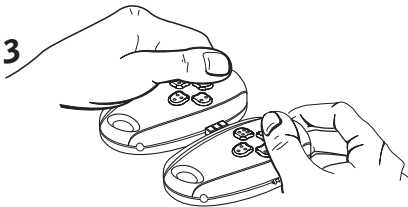

### Step 3

- Actuate the desired button of the new hand transmitter and hold the button of the existing hand transmitter.

After 1 - 2 sec. the LED on the new transmitter is glowing permanently.  
Programming is terminated.

The new hand transmitter has now taken over the coding of the existing hand transmitter.

- Remove the coding plug ①.

## Altering the coding

It is possible to change the coding of the hand transmitter in case that a hand transmitter has gone lost.

For this insert the coding plug ① into the hand transmitter that has to be reprogrammed.

1

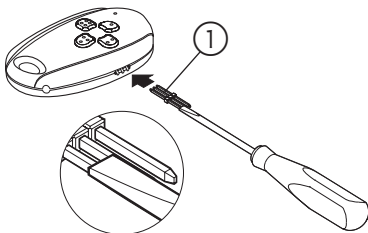

### Step 1

- Insert the coding plug ① into the hand transmitter.
- Short-circuit one of the outer pins of the coding plug with the centre lead (e.g. by means of a screwdriver).
- Actuate the desired button on the hand transmitter. The integrated random program generates a new code. The LED is flashing quickly.

As soon as the LED on the hand transmitter is on permanently, release the button of the hand transmitter and remove the coding plug.

## LIMIT CAM POSITION (REFERENCE POINT CLIP)

In case you have to install a new limit cam on to your chain, please follow below instructions. It is only possible to install a clip onto a chain. When you have a belt drive boom, it is not possible to reinstall a limit cam.

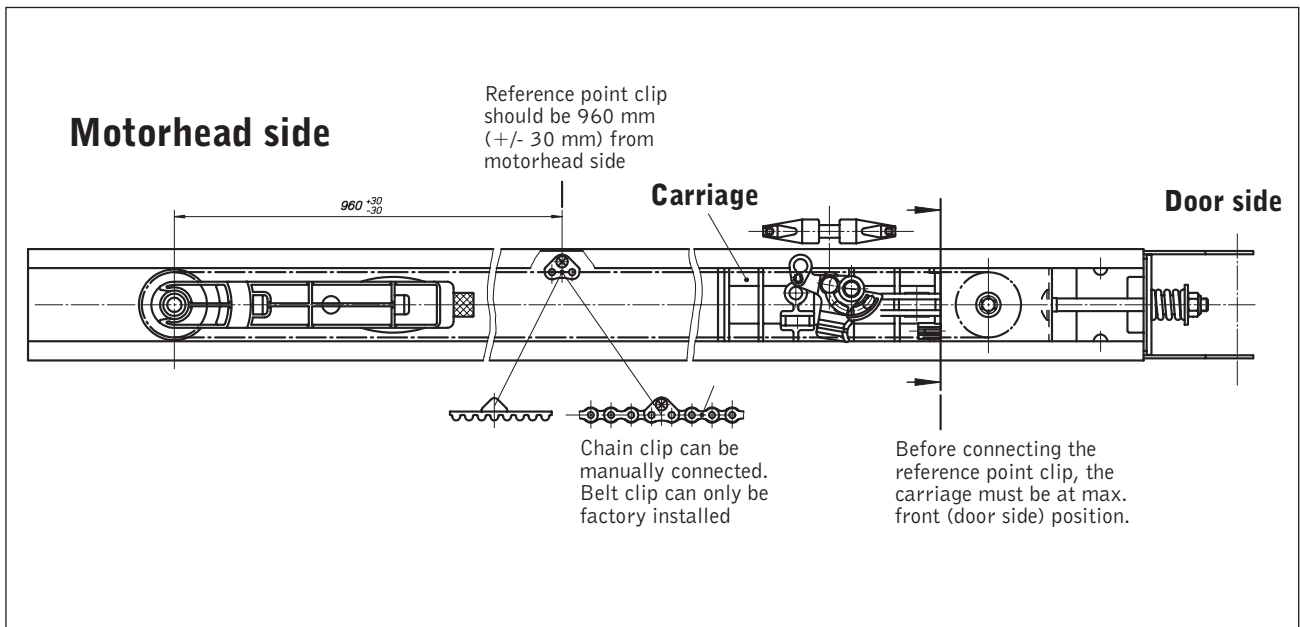

## EXTERNAL CONNECTIONS

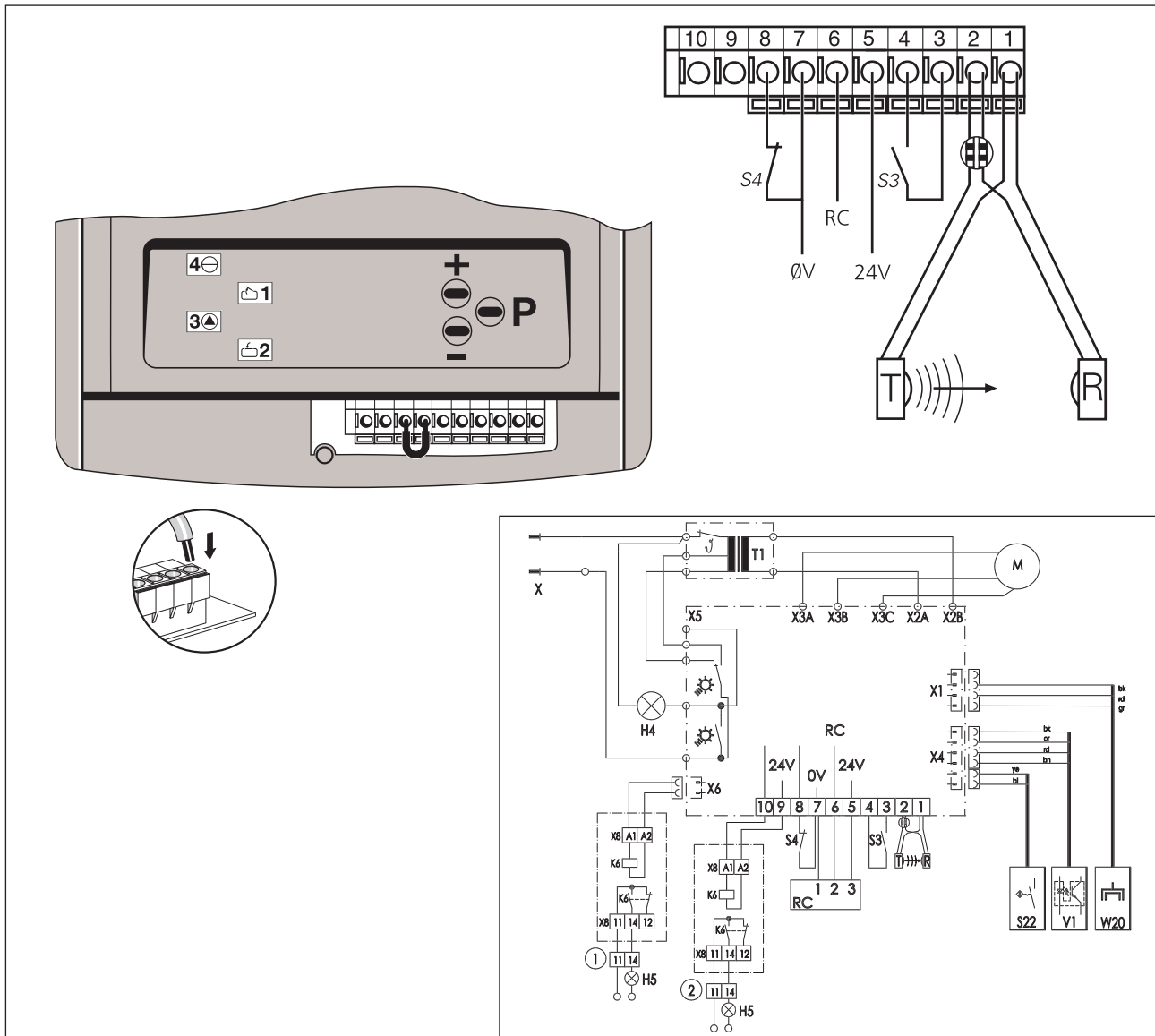

- M motor
- T1 transformer
- V1 RPM sensor
- S22 reference point switch
- T photocell transmitter
- R photocell receiver
- S3 push button IMPULSE
- S4 push button STOP
- X1 plug 1~N 220-240V 50Hz
- X3A flat cable connector dc motor
- X2C ground
- X2A and X2B = 24V
- X6 Relay output contact 1
- H4 Operator light
- H5 signal light
- ① internal relay (optional)
- ② external relay (optional)
- W20 Receiver HF module output
- 24V 24 VDC, 50mA max.

- 0V masse (ground)
- RC Contact
- bk black
- bn brown
- or orange
- rd red
- gr green
- bl blue
- ye yellow

### Wall control (push button impulse):

It is possible to either connect a push button or a 3-function wall console with impulse, light on/off and an electronic vacation lock functions. When operator LED 4 burns and LED 3 flashes the 'vacation' lock is actiated. De-activate 'vacation' lock on 3-function wall console or by briefly pressing **⊖P** button on operator.



## TROUBLESHOOTING

Fault	Cause	Remedy
Indicator 4 does not glow.	No voltage.	Check mains supply. Check electric socket.
	Thermal protection in mains transformer activated.	Allow mains transformer to cool down.
	Defective control unit.	Cut off mains supply to operator. Remove lamp cover and motor cover. Unscrew control unit, pull slightly forward and withdraw the connecting plug. Remove control unit and have it checked.
Indicator 3 flashes. Error 5 or 8	Automatic cut-out set too sensitively. Door operation too sluggish. Door blocks.	Re-set automatic cut-out to be less sensitive (Level 2, Menu 2 and 3 page 20). Ensure door moves easily.
Indicator 3 flashes. Error 3 or 7	External photocell defective or interrupted.	Remove obstruction or have photocell checked.
Drive only operates in "OPEN" but not in "CLOSE" direction. Error 7	Photocell programmed, but not connected (Level 2, Menu 1 page 20).	Reprogramme photocell function or connect photocell.
No response on impulse. Indicator 3 glows.	Connecting terminals for "IMPULSE" button bridged, e.g. due to short-circuit or wrong terminal connection.	Temporarily isolate cabled key switches or interior push buttons from control unit. Remove plug, insert plug and look for cable fault.
No response on impulse. Error 10	Short-circuit label removed, but "STOP" button not connected.	Connect "STOP" button.
Indicator does not flash rapidly on impulse from hand transmitter	Hand transmitter coding is not consistent with receiver coding.	Check coding Menu 5, page 13.
	Flat battery.	Insert new battery. Flashing LED in transmitter indicates battery condition.
	LED 3 does not light up when pressing transmitter button	Electronic aerial not connected or wrong installation
	Hand transmitter or control unit defective.	Have both components checked.
Insufficient range of remote control (less than 5 m).	Flat battery in hand transmitter.	Insert new 12V A 23 battery. Flashing LED in transmitter indicates battery condition.
Indicator 3 flashes. Error 10	RPM sensor defective.	Have operator checked.
	Door too sluggish.	Check door.
Transmitter command does not respond but wall control does (LED 4 on, LED 3 flashes)	Operator is in electronic 'vacation' lock	De-activate 'vacation' lock on 3-function wall console or by briefly pressing  button on operator.

## ERROR MESSAGES

When LED **3** is flashing the error message can be retrieved by pressing **OP** briefly.

The total sum of numbers in blinking LEDs indicate the so-called error number.

LED flashes erratically	Error number	Fault
<b>3</b>	3	Photocell actuated
<b>1</b>	1	Programming aborted
<b>2</b>	2	Reference point switch defective
<b>4</b>	4	Defective RPM sensor Anti-lock system actuaed
<b>4</b> + <b>1</b>	5	Power limit
<b>4</b> + <b>3</b>	7	Excess travel stop
<b>4</b> + <b>3</b>	7	Photocell self-monitoring unit not o.k.
<b>4</b> <-> <b>3</b>	7	Voltage monitoring is active
<b>4</b> + <b>3</b> + <b>1</b>	8	Power limit self-monitoring unit
<b>4</b> + <b>3</b> + <b>1</b>	8	Learned power limit
<b>4</b> + <b>3</b> + <b>1</b>	8	Response sensitivity of power limit
<b>4</b> + <b>3</b> + <b>2</b> + <b>1</b>	10	NC contact (Terminal 7&8) broken



### Attention:

Programming the advanced features of this operator must only be undertaken by fully trained and qualified personnel. Please contact your dealer for details.

## Level 2 ADVANCED SETTINGS

### MENU OVERVIEW **Level 2**:

- ① Add beam break (photocell)
- ② Set maximum OPENING force
- ③ Set maximum CLOSING force
- ④ Set offset learned power limit (sensitivity)
- ⑤ Set start-up phase
- ⑥ Set "operator speed"



### Advice:

The values for the automatic cut-out (= max. force) and learning power limit (= power curve) can be set manually in the 2nd programming level.

A setting should always be carried out as soon as a less sensitive setting has to be chosen due to door travel properties caused by site conditions, as otherwise the automatic cut-out or power limit would react and cause malfunctions.

In general you have to take care that the allowed operating forces according to EN 12445 and EN 12453 are not exceeded.



### Advice:

The setting of the automatic cut-out corresponds to the maximum power of the operator. At the first travel to OPEN or CLOSE direction after 'POWER ON' the automatic cut-out is effective according to the adjustment. For further travels the self-learned power, that is more sensitive, is effective. The automatic cut-out is still the upper limit of power.











## To SET UP ADVANCED SETTINGS:

### Level 2 Menu 1

#### ADD BEAM BREAK\*

\*Beam break is an optional accessory.

Operator is in normal operating mode.

1. Press  for 10 seconds until LED  flashes rapidly and all others are illuminated.
2. Release  where after LED  blinks and all others are illuminated.
3. A. Press  if a beam break is to be installed (LED  illuminated)  
B. Press  if no beam break is to be installed (LED  blinks rapid)
4. Press  to store settings and to go to Menu .

### Level 2 Menu 2

#### SET MAXIMUM OPENING FORCE AND



#### Attention:

The automatic cut-out is set automatically.  
Only change it if necessary (error No. 5).

When increasing the set value the max. force in OPEN direction is increased and thus the sensitivity of the automatic cut-out is reduced.







#### Attention:

































Always test the max. allowed operating forces according to EN 12445 and EN 12453!





#### Advice:

The setting of the automatic cut-out corresponds to the maximum power of the operator. At the first travel to OPEN or CLOSE direction after 'POWER ON' the automatic cut-out is effective according to the adjustment. For further travels the self-learned power, that is more sensitive, is effective. The automatic cut-out is still the upper limit of power.

1. LED  and LED  blink and all others are illuminated.
2. By pressing  and  set the desired maximum lifting force.  
Each illuminated LED represents 1/8 of the maximum total force.

 	 	 	 	 	 	 	 
 	 	 	 	 	 	 	 
1/8	2/8	3/8	4/8	5/8	6/8	7/8	8/8

3. Once maximum opening force is set press  to store and go to Menu .



#### Attention:

When re-programming the end positions (1st programming level) the opening force is learned once more.

With new setting of the end positions the force values are determined automatically.

Depending on the door travel properties increasing of the force values may be necessary.



**Attention:**

The automatic cut-out is set automatically.  
Only change it if necessary (error No. 5).

When increasing the set value the max. force in OPEN direction is increased and thus the sensitivity of the automatic cut-out is reduced.







**Attention:**

Always test the max. allowed operating forces according to EN 12445 and EN 12453!



**Advice:**

The setting of the automatic cut-out corresponds to the maximum power of the operator. At the first travel to OPEN or CLOSE direction after 'POWER ON' the automatic cut-out is effective according to the adjustment. For further travels the self-learned power, that is more sensitive, is effective. The automatic cut-out is still the upper limit of power.

1. LED  and LED  blink and all others are illuminated.
2. By pressing  and  set the desired maximum closing force.  
Each illuminated LED represents 1/8 of the maximum total force.

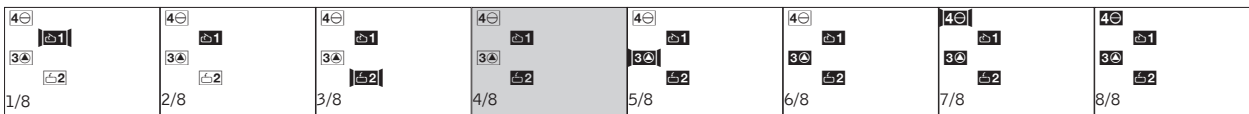

3. Once maximum opening force is set press  to store and go to Menu 4.



**Attention:**

When re-programming the end positions (1st programming level) the closing force is learned once more.

With new setting of the end positions the force values are determined automatically.

Depending on the door travel properties increasing of the force values may be necessary.

**Level 2** Menu **4**

SET OFFSET AUTOMATIC LEARNED POWER LIMIT **3**



**Attention:**

The learning power limit is set automatically.  
Only change it if necessary (error No. 8).

When increasing the set value the offset in OPEN and CLOSE direction is increased and thus the sensitivity of the learning power limit is reduced.



**Attention:**

Always test the max. allowed operating forces according to EN 12445 and EN 12453!

1. LED **3** blinks and all others are illuminated.
2. Use  $\uparrow$  or  $\downarrow$  to change offset in increments of 1/16 of the maximum.  
 minimum offset: 1/15  
 maximum offset: 15/15

4 3 2 deakti- vated	4 3 2 1/15	4 3 2 2/15	4 3 2 3/15	4 3 2 4/15	4 3 2 5/15	4 3 2 6/15	4 3 2 7/15	4 3 2 8/15	4 3 2 9/15	4 3 2 10/15	4 3 2 11/15	4 3 2 12/15	4 3 2 13/15	4 3 2 14/15	4 3 2 15/15
---------------------------------	---------------------	---------------------	---------------------	---------------------	---------------------	---------------------	---------------------	---------------------	---------------------	----------------------	----------------------	----------------------	----------------------	----------------------	----------------------

3. Press **P** to store and go to Menu **5**.

**Level 2** Menu **5**

SET START-UP PHASE **4**

1. Make sure LED **4** is blinking and all other are illuminated.
2. Use  $\uparrow$  or  $\downarrow$  to change start-up warning phase.
  - a. No start-up warning
  - b. 2 second start-up warning with external signal relay blinking
  - b. 2 second start-up warning with external signal relay illuminated
 There are 3 settings; blinking LED **1** represents A; illuminated LED **1** represents B and illuminated LED **1** and blinking LED **2** represents C.

4 3 2 A	4 3 2 B	4 3 2 C
------------------	------------------	------------------

3. Press **P** to store and go to Menu **6**.

## Level 2 Menu 6

SET "OPERATOR SPEED" **3** AND **4**

1. LED **3** and **4** blinks rapidly and all others are illuminated.
2. Use **+** or **-** to change the operator speed in steps of 2/8 to 8/8 (factory settings).  
minimum speed: 3/8  
maximum speed: 8/8

<b>4</b> <b>3</b> <b>1</b> <b>2</b> 1/8	<b>4</b> <b>3</b> <b>1</b> <b>2</b> 2/8	<b>4</b> <b>3</b> <b>1</b> <b>2</b> 3/8	<b>4</b> <b>3</b> <b>1</b> <b>2</b> 4/8	<b>4</b> <b>3</b> <b>1</b> <b>2</b> 5/8	<b>4</b> <b>3</b> <b>1</b> <b>2</b> 6/8	<b>4</b> <b>3</b> <b>1</b> <b>2</b> 7/8	<b>4</b> <b>3</b> <b>1</b> <b>2</b> 8/8
--	--	--	--	--	--	--	--

3. Press **OP** to store and to finish setting up the operator speed and level 2 settings.

The LEDs will automatically turn off starting at LED **4** and ending at LED **1**.  
Operator is now in operational (normal) mode (recognizable by illuminated LED **4**) and possible LED **1** (door fully open) or LED **2** (door fully closed).

## TECHNICAL SPECIFICATIONS

### DC-650N II Garage Door Operator

#### Connected loads:

230 V  
200 W (in operation with lighting)  
3.9 W (out of operation without lighting)

#### Door travel speed:

0.14 m/s with "soft" start and "soft" stop

#### Push and pull force:

650 N

#### Excess travel stop:

88 secs.

#### Lighting:

1 x 40 W E14

#### Control voltage:

Low voltage below 24 V DC.

#### Automatic cut-out:

Electronic power limit through microprocessor and power sensor.

#### Anti-Block system:

Through microprocessor and RPM sensor.

#### Device to prevent forced opening of door:

Electronic back-drive prevention by permanent protection of the closed door position.  
Door will automatic close after ca. 1cm detected unauthorized reverse movement.

#### Protection category:

For dry buildings only.

**⚠ Attention:** Observe local regulations!  
Always lay mains cable (230V) and control wire (low voltage) separately.

**⚠ Attention:** Only operate garage door when certain there is no person or object in garage door opening and travel path.

### Maintenance

This garage door operator is virtually maintenance-free.

However, all movable parts of the door and operator system should be checked regularly and kept in an easily movable condition.

The OPEN and CLOSE automatic cut-out settings should be checked regularly.

The door must be running smoothly and regularly maintained. Check the lifting regularly.

## MAIN UK & EIRE DISTRIBUTOR:

Cardale Doors Ltd.  
Brackley  
Northants  
NN13 7EA  
England

Tel: 01280 703022  
Fax: 01280 702195

CARDALE  
GARAGE DOORS



Art.-Nr.: 67 094  
Version: 09.2004



# SHORT PROGRAMMING MODEL O SERIES II

## Basic Settings:

Press **P** for 2 sec. until LED **1** blinks and all others are illuminated.

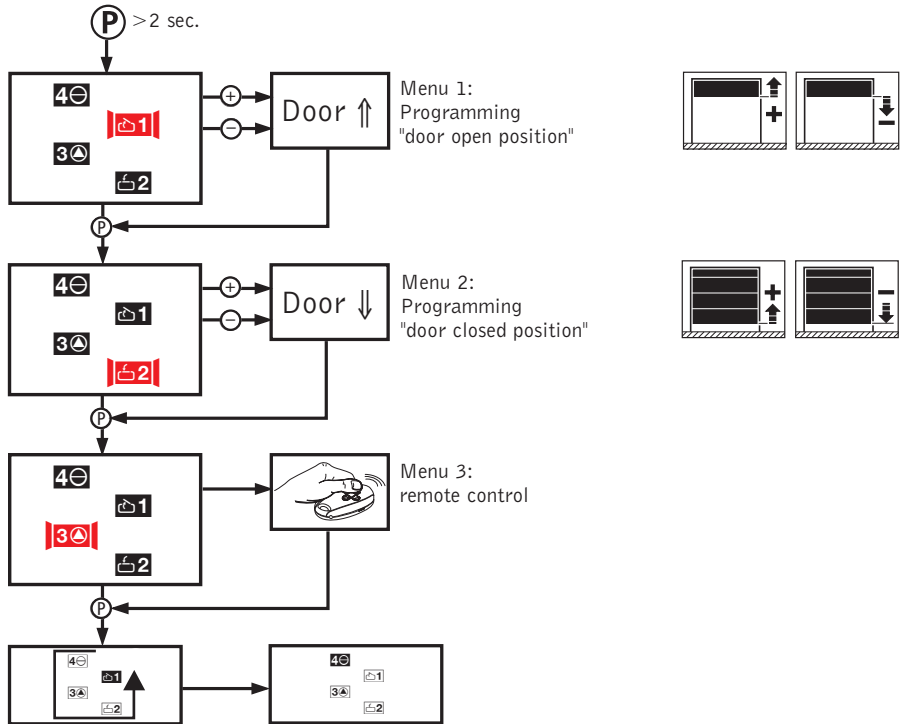

## Advanced Settings: Level 2

Press **P** for more than 10 sec. until LED **1** blinks rapidly and all others are illuminated.

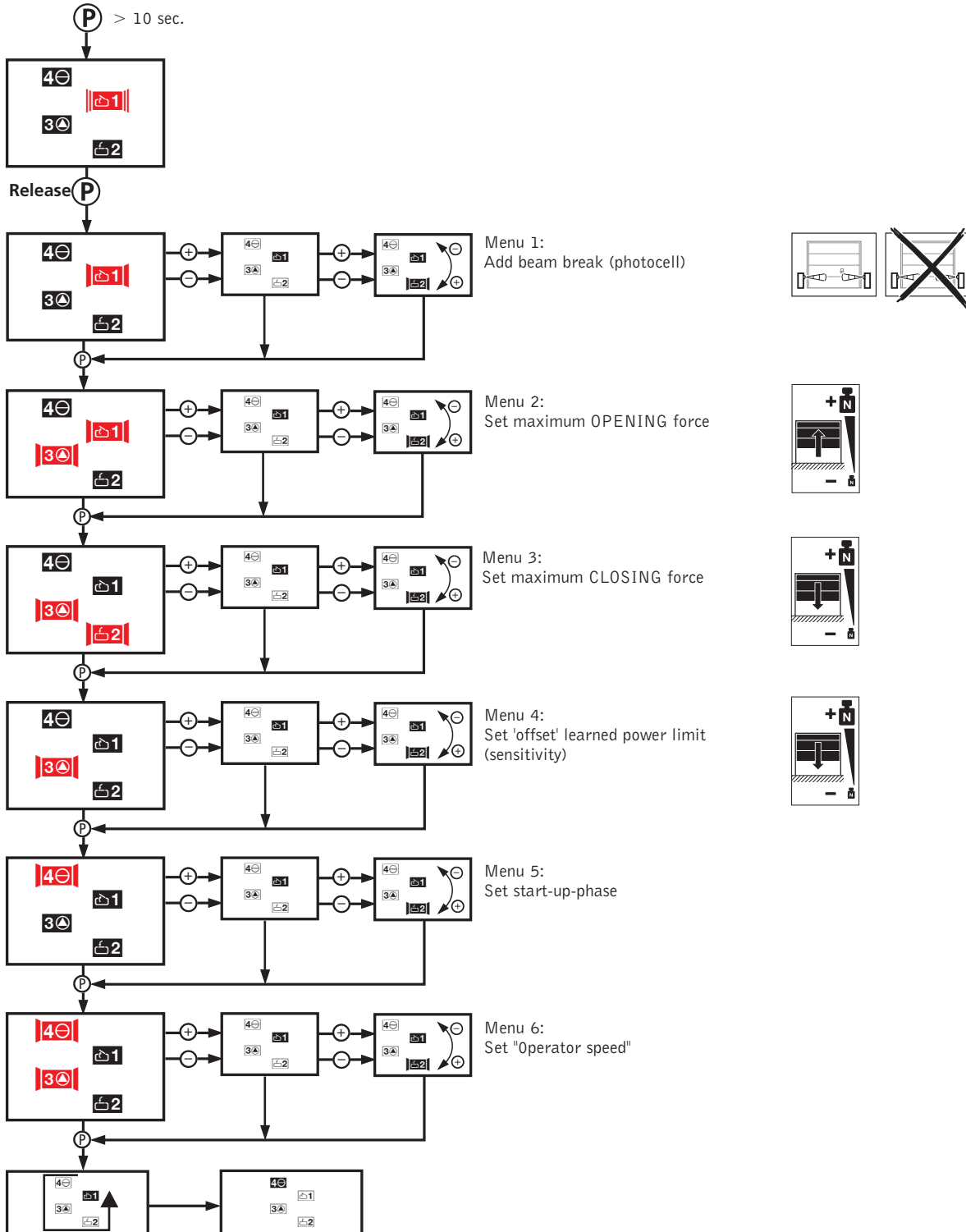

# Supply of Machinery (Safety) Regulations 1992

## EC Declaration of Incorporation

### Powered Garage Door Operators

The powered garage door operator models listed below are intended to be incorporated with a suitably designed garage door (see matrix below) to provide powered operation.

Figures refer to maximum aperture width (mm), maximum aperture height (mm) and maximum door weight (kg) respectively.

Door type	Operator suitability			
	DC-650N (standard boom)	DC-650N (extended boom)	DC-800N (standard boom)	DC800N (extended boom)
Slide away	5030/2410/85	5030/2630/85	5182/2410/100	5182/2630/100
Sectional (with torsion spring)	5030/2160/85	5030/2410/85	5182/2160/100	5182/2410/100

Samples of powered door operators of the above types have been tested/checked and found to conform with the provisions of the Machinery Directive (98/37/EC), the Low Voltage Directive (73/23/EEC) and the E.M.C. Directive (89/336/EEC).

A powered door operator must not be put into service until it has been completely and safely assembled and installed, with an appropriate type, size and weight door, in accordance with the door and operator manufacturer's fitting instructions, using a suitable connection arm and appropriate safety devices, etc; and not until the complete installation has been declared to be in conformity with the provisions of the Machinery Directive.

The technical files for the operators listed above are held by Cardale Doors Ltd. and will be made available for inspection by an enforcing authority, should the need arise:-

This Declaration is made by:



C. Parkman, Operations Director

Being the responsible person appointed by the manufacturer and employed by:

Cardale Doors Ltd. Registered Office: Arundel House, Arundel Road, Luton, Bedfordshire. LU4 8DY  
Registered No. 926537 (England)

# DECLARATION OF INCORPORATION

This Declaration of Incorporation has been prepared by the powered garage door operator manufacturer to meet the requirements of the Supply of Machinery (Safety) Regulations {Machinery Directive} and signifies that the accompanying powered garage door operator, if installed in accordance with the manufacturer's detailed instructions, will be suitable to be incorporated with a suitably designed garage door with a compatible Declaration of Incorporation.

It is the responsibility of the installing company to ensure that doors and drive units are correctly matched prior to installation.

It is also the responsibility of the installing company, as the Responsible Person, to ensure that a suitably nominated person should confirm that the power operated door has been installed in accordance with the instructions provided by both the door and drive unit manufacturer.

It is also the responsibility of the installing company to check after installation the operation of the power operated door and that any safety devices provided are suitable for the application and are all working satisfactorily. This will permit the nominated person to attach a CE label identifying the name of the installing company, a unique door reference number and a date of completion, and to complete and issue a Declaration of Conformity (see note below).

One copy of the Declaration of Conformity is to be issued to the client and one copy is to be retained by the installing company, together with the relevant two Declarations of Incorporation. In accordance with the requirements of the Machinery Directive and the UK supply of Machinery (Safety) Regulations, these records are to be retained on file for a period of ten years.

## NOTE

Duplicate printed pads set out in the format of Declarations of Conformity in order to allow on site completion are available at a reasonable cost from the DSMA for both members and non-members. Alternatively, for an additional cost, a technical records file with full details of requirements and procedures for compliance, and including the necessary filing divisions, is also available.



The Door & Shutter Manufacturers' Association, 42 Heath Street,  
Tamworth, Staffordshire B79 7JH Telephone: 01827 52337 Fax: 01827 310827